



Discovery EXPRESS

Vol. 8, No. 4

Fall 2006

IN THIS ISSUE

President's Message	2
Congratulations	2
Rally Schedule	3
Thoughts and Prayers	3
2007 SE Region Rally Report	4
2007 National Rally Report	4
Founders' Forum	5
Rally Master's Report	5
Region Reports	
Southeast	5
Northeast	6
Feeding the RVer	6
DOAI Board	7
Chapter Presidents	7
Helpful RV Contacts	7
Chapter Reports:	
Discovery Pioneers	8
Arizona Discovery Owners	8
Northwest Adventurers	8
Heartland Discoverys	8
California Goodtimers	9
Mason-Dixon Discoverys	9
Louisiana Mudbugs	9
Discovery Texans	9
New Members	10
Membership Sponsors	10
RV Videocasts via Internet	10
Discovery Modifications	11
Cold Weather Camping Tip	12
Winterize the RV	13
"Fuel-ish" Question	13
Keeping in Touch	14
eGroup Conversation	15
From Then to Now	16
RV Education 101	17
Fighting Small Fires	18
Dr. Dometic	19
2007 SE Region Rally Form	20
Sale Page for Members	21
2007 National Rally Form	22
Editor's Ramblings	23
Membership Form	23

With RVs, you have all the conveniences of a first class hotel right behind the driver's seat. You don't have to make reservations. You just say, 'Let's hop in the RV and go!'

— Mark Orwoll, managing editor
Travel & Leisure Magazine

WELCOME, FALL!
**Check inside this issue
for information, RV
help, and more!**



2007 SOUTHEAST REGION RALLY

**2007 Southeast
Region Rally**



Plans are gelling, excitement is rising, and the strawberries will be at their peak of perfection! Plan now to attend the Southeast Region's winter rally at Lazydays RallyPark in Seffner, Florida, next February. It'll be **Sun-N-Fun** time in the Sunshine State! See page 4 for more information, and page 20 for a registration form. You can also go to www.discoveryowners.com and download a registration form.

2007 NATIONAL RALLY

Arizona Discovery Owners chapter will host the 2007 national rally at El Pueblo RV and Golf Resort in El Mirage, Arizona, next November, where there will be **Discoverys in the Desert.**

Barbara Klusman, chapter president, has more information for you on page 4, and the registration form is on page 22. There's even a tentative plan for a rolling rally to precede the national rally. See President Phil's comments on page 2.



*Quarterly Publication of Discovery Owners Association, Inc.,
an organization by and for owners of Fleetwood RV Discovery Motor Homes*

© 2006 DISCOVERY OWNERS ASSOCIATION, INC.

Discovery Owners Association, Inc. is not responsible for opinions or facts presented in this newsletter by contributors.

This newsletter is **published** four times annually (Winter, Spring, Summer, Fall). **Deadline** for copy is November 20, February 20, May 20, and August 20. Members are encouraged to send in articles, tips, questions, and/or comments.

Material for the newsletter may be sent via e-mail or U.S. Post Office. Photos are welcome, and if sent via e-mail, should be in either .jpg or .bmp format. Photos sent by regular mail will be scanned and returned to contributors. **All submissions will be acknowledged.** If acknowledgment is not received within a reasonable time, please call the editor.

Toll-free numbers for officers and chairmen are to be used **only** for DOAI business.

NEWSLETTER EDITOR

Nina Lee Soltwedel
4736 Harwich St.
Boulder, CO 80301-4217
888.786.2962
nina.soltwedel@gmail.com

Please contact DOAI membership director as soon as you change your address. Newsletters are costly to mail, and DOAI pays double when a newsletter is returned.

MEMBERSHIP DIRECTOR

Portia Williams
P. O. Box 95
St. George, UT 84771-0095
888.594.6818
rgwilliams@sisna.com

DOAI WEB SITE

www.discoveryowners.com

DOAI EGROUP

www.groups.yahoo.com

PRESIDENT'S MESSAGE

by Phil Yovino



We have, without a doubt, one great club. The other day I was searching my mind on what I wanted to say to you this quarter; what things are most important and of

interest to all members. So, I stopped and took a long look at the events that have taken place over the past quarter.

In the last newsletter, we mentioned the success of the California Goodtimers chapter. Gerald Embry and wife, Julia, reported that, at last count, 32 members planned to attend the first outing September 15-18. Contact Gerald at gembry@verizon.net or 877.238.6954 and join the Goodtimers for fun and fellowship. The gathering of Discovery owners by this revived chapter was a milestone for their success. If you are near or in the Southwest Region, try to attend their future rallies to show your support.

In early August, Dot and I attended a chapter rally with the Texas Disco Road Runners. We worked on the final arrangements for the upcoming national rally. Road Runners' president, Garry Shirey, and Jay Keneson, national rally master, have done a super job putting things in order to have a great rally at a super RV park. From the welcome party (this will be fun) to the closing night of good food and entertainment, you're sure to have a good time. Every effort has been taken to insure a full week of pleasure and enjoyment for the members. The big plus is Fleetwood will be there to provide service October 4, 5, and 6. We hope to see **you** there!

Dick Smith and wife, Sue, along with the Mason-Dixon Discoverys chapter, are well on their way with the **Sun-N-Fun** rally at Lazydays RallyPark in February 2007.

Pull out the registration form (see page 20 or the DOAI Web site), fill it out, and send it to Marshall Godwin. Only 150 spaces are available. We always have a great time there, renewing our friendships, along with all the amenities, including the strawberry shortcake with ice cream.

In August, while going over plans for our 2007 national rally with Barbara Klusman, president of the Arizona Discovery Owners, I mentioned we could arrange a rolling rally in Arizona and Utah. This would take place before the national and would offer members interested in seeing this beautiful part of our country the opportunity to do so with other Discovery owners. Barbara thought this was a great idea and offered to collect information on camp sites, parks, and all the places of interest in the area.

Later, I spoke with our membership director, Portia Williams, who lives in Utah, about the rolling rally, and Portia said she would also help with the planning. If you think this is something you might be interested in, let me know so we can start planning. I'm thinking we can manage 25 or 30 coaches. My guess is we can make this a 7-14 day rolling rally. If we receive enough interest, we will be able to put a cost together for all to consider.

Every day I read mail and also view the eGroup. Bob Cook has put together and maintains our Discovery Web site, which is far and away above any other site in the RV sector. As I viewed the eGroup, I saw members helping members solve everyday coach problems, from finding the correct oil filter, fan belt, to solving foul odors in the coach. The great thing about it is how fast we get a response, and not from just one but many. I can only guess how much time and money it saves us to have this information so readily available. Thank you, Bob. You do outstanding work.

Have safe travels and good health. ❖

CONGRATULATIONS!

As announced in the Fall 2005 issue of this newsletter, DOAI members can earn a year's membership by enrolling three new members into the organization.

Portia Williams, DOAI's membership director, announces the first couple to earn this free year's membership:

Bob and Nina Soltwedel

You too can earn a year's membership! Talk up DOAI to other Discovery owners, hand out DOAI brochures, and tell others about the benefits of belonging to this super organization for Discovery owners. Your region vice president has a supply, as do chapter presidents. Not sure who your region vice president is?

See the listing on page 7.

RALLY SCHEDULE

OCTOBER 2006 –

1-7 National Rally, *Discover the Alamo*, Blazing Star RV Resort, San Antonio TX

NOVEMBER 2006–

3-5 Louisiana Mudbugs, Bayou Wilderness, Carencro LA

10-13 Florida Discovery Rolling Gators, Riverside RV Resort, Port Charlotte FL

16-18 Discovery Texans, Skyline Ranch, Bandera TX

30-Dec 3 Arizona Discovery Owners, Park T/B/A, Yuma AZ

DECEMBER 2006 –

T/B/A Florida Discovery Rolling Gators, Christmas Airstream Park, Titusville FL

8-10 Texas Disco Road Runners, Fredericksburg KOA, Fredericksburg TX

JANUARY 2007 –

18-20 Discovery Texans, Oasis RV Park, La Marque TX

FEBRUARY 2007 –

13-17 Southeast Region Rally, *Sun-N-Fun*, Lazydays Rally Park, Seffner FL

MARCH 2007 –

15-17 Discovery Texans, Buckhorn Lake Resort, Kerrville TX

MAY 2007 –

17-19 Discovery Texans, Schulenburg RV Park, Schulenburg TX

JUNE 2007 –

4-8 Midwest Discoverers, Sauder Village, Archbold OH

14-19 Nor'easters, Cape May Seashore, Cape May, NJ

SEPTEMBER 2007 –

20-22 Discovery Texans, Cowtown RV Park, Aledo TX

OCTOBER 2007 –

31-Nov 2 Discovery Texans, Park T/B/A, Abilene TX

NOVEMBER 2007 –

6-10 National Rally, *Discoverys in the Desert*, Pueblo El Mirage RV Resort, El Mirage AZ

Send an e-mail to the editor with your rally schedule, and don't forget to add it to your chapter page at www.discoveryowners.com. ❖



...**Dixie Reese**, who had open heart surgery in May.

...**Lew Sharpe**, whose ill health necessitated selling his Discovery.

...**Marjorie Jestes**, whose husband, **James**, died in April after a short illness. Marjorie has moved to California, to live with their daughter.

...**Valerie Stanley**, whose husband, **Stan Stanley**, died in July.

...**Ken Wilkins**, who had hip revision surgery in July. He reports he is "doing well."

...**Gar Collick**, whose wife, **Judy**, died in June. Gar wrote: "I still have our beloved 'D' and will continue to put miles on her. Have 113,000 now and am shooting for 500,000! I figure Fleetwood used a Freightliner/Cummins combination for a reason. I hope to make it to some of the DOAI doings soon."

...**Betty Brooks**, whose husband, **Jack**, died in July.

...**Ellen Blakely and family**. Husband and father **Raymond** passed away in March. Son **Richard** and wife **Janet** took over the 'D' and are now members of DOAI.

...**Jan Dodd**, who has had back surgery, and may need more surgery.

...**Dorothy Devine**, who has embarked on a new treatment plan to reduce the pressure in her lungs, and is now out of hospice.

...**Arlene Richie**, who is undergoing chemotherapy.

...**Jane Colburn and family**. Husband and father **Ed** died in November 2005. Jane wrote: "Hello to everyone. I miss the club and all the good people." Remember *Mr. Ed Badges 'n Signs?* That was Ed and Jane.

Please continue to let either our membership director, **Portia Williams**, or our newsletter editor, **Nina Soltwedel**, know of any members or their families who need a card filled with kind thoughts and prayers from the DOAI family. ❖

Please keep these DOAI members and their families in your thoughts and prayers:

...**Frank Sawyer**, as he continues to cope with diverticulitis.

...**Jerry Wiechman**, as he recovers from knee replacement surgery. His therapy is proceeding well and he and wife **Joyce** hope to be on the road again real soon.

...**Pat Cutler**, whose ill health has necessitated selling their Discovery. Husband **Mike** wrote: "We hated to sell our 'D' as we have really enjoyed the coach and being members of DOAI."

2007 SOUTHEAST REGION SUN-N-FUN RALLY

The Mason-Dixon Discoverys request the honor of your presence at **2007 Southeast Region Sun-N-Fun** rally at Lazydays RallyPark, February 13-17, 2007. That's five days and four nights in Seffner, Florida!



Lazydays RallyPark

Our agenda includes:

- February 13 - Welcome Party
- February 14 - Cookout
- February 15 - Catered Dinner followed by Entertainment
- February 16 - Catered Dinner followed by Entertainment

We'll also have seminars, vendors, Red Hat tea, golf outing, cash prizes, door prizes, handouts, chapter meetings, board meetings, and region meetings!



Located in Seffner, Florida, Lazydays RallyPark is famous for its amenities including: Newspaper at your coach every day; trash pick-up at your door anytime; full hook-ups with 30 and 50 amps; complimentary breakfast and lunch at the Lazy Days Café weekdays; approximately 1,000 brand new RVs on the premises to look at and go through; Camping World on the premises; Flying J on the premises; Cracker Barrel on the premises.

We have reserved 150 sites. Y'all come to Florida and enjoy the sunshine and hospitality...the strawberries and whipped cream...the **Sun-N-Fun!** ❖

2007 NATIONAL RALLY – 10TH ANNUAL RALLY!

Discoverys IN THE DESERT
NOVEMBER 6-10, 2007

EL PUEBLO RV AND GOLF RESORT, EL MIRAGE, ARIZONA

The weather forecast for November in Arizona is sunny with the average temperature around 70 degrees. Based on that, the next national DOAI rally, set for November 6-10, 2007, should have a sunny time. The setting is the El Pueblo Golf and RV Resort, El Mirage, Arizona. Pueblo El Mirage RV Resort is conveniently located in the heart of Arizona's dramatic Sonoran Desert, home to some of the most spectacular scenery in the American Southwest.



The official start will be on Tuesday afternoon, November 6, with a first-timers welcome get-together, followed by the official welcome party for our entire DOAI family.



Heard Museum

We will have optional tours prior to the official start of the rally. Plans for a golf tournament, trips to the Heard Museum, and a tour of Luke Air Force Base are in place.

Quality meals are our goal, and with the help of the resort's food management team, we are assured that we will meet that goal.

With approximately 13 months to go to rally time, Arizona is striving to host another great DOAI rally. It's our turn to give a good time to all the other chapters that have hosted previous national rallies.

See the registration form on page 22...it's not too early to get your reservation in. We have a limit of 150 coaches, and we don't want **you** to be left out.

Mark your 2007 calendar for November 6-10, and together we'll celebrate ten years of DOAI national rallies! **Come join us!** ❖



Jets from Luke AFB



Pueblo El Mirage entrance

FOUNDERS' FORUM *by Jim and Dorothy Devine*

Pursuit of Happiness

We Discovery owners, I believe, choose to leave safe harbor to sail out of the familiar shipping lanes, to go into uncharted waters. Each of us is in search of our own 'holy grail.'



As we navigate through the open seas of life, we encounter the perils of those uncharted waters. We take these risks in the pursuit of happiness. We may define it more specifically, such as to find a sheltered cove, or sail around an approaching storm.

To me, happiness seems fleeting, elusive. One of the things that makes it this way is it's a state of mind and for each of us, that changes from day to day.

True happiness is only achieved when combined with contentment. I am not sure which comes first, or if one can exist without the other. And finally, I think this indescribable feeling called 'happiness' must be shared if one is to feel true happiness.

This is my message to all: Value your loved ones and be inspired by their presence. Sharing those magical moments adds richness and meaning to our lives. ❖

Editor's Note: Jim and Dorothy send heartfelt thanks to all who have called and sent cards. Dorothy is embarking on a new course of treatment, aimed at reducing the pressure in her lungs. This was caused by a long-ago case of rheumatic fever which destroyed her mitral valve. This has allowed blood to build up in her lungs. Please continue to keep them both in your prayers.

RALLY MASTER'S REPORT *by Jay Keneson*

As I write this, it is around this time last year when we gathered in York, Pennsylvania, for yet another great DOAI national rally.

Over two years ago, we started planning the 2006 rally in San Antonio, Texas, *Discover the Alamo*. During this time progressive actions have been ongoing. These include multiple meetings, phone conferences, e-mails, planning and working rallies with the chapters co-sponsoring the event, and other activities and work necessary to prepare for your arrival and insure a good time and a meaningful rally.



By the time your copy of this newsletter is in your mail box, most of you who are attending will be on the road or will have arrived in San Antonio and the rally will be in full swing. We are sorry if you could not attend. We will miss you sharing the San Antonio experience we have planned. In the winter issue of *Discovery EXPRESS* we will let you know what you did miss.

Remember, we hold our annual national rally on a rotating basis in one of six different regions of the U.S.A. This allows those who prefer a shorter destination from home to choose a future national rally in a more proximate location. Those of us who delight in visiting new and diverse areas will, of course, continue to attend every national rally possible.

The planning for the 2007 national rally started around the

time the York rally ended in 2005. This next rally, themed *Discoverys in the Desert*, shows great promise to be another outstanding event. It will be held at the Pueblo El Mirage RV Resort in El Mirage, Arizona, a suburb of Phoenix. I visited this site in January 2006 and can tell you that the facilities are most impressive! The group sponsoring the rally is a well-organized and hard-working bunch and they are making positive progress in all phases of rally preparation.

So where are we going in 2008? The exact location has not yet been finalized. However, the site rotation planning cycle places us in the Southeast Region. This is a large area including 12 states from which to choose. Truly, it will be difficult to select from so many wonderful possibilities. I know that several great suggestions have been made and that the region's vice president, Dick Smith, has been carefully and diligently researching, considering and reconsidering, in order to select the best of the best for you. Once possibilities or a selection is determined, I will try to visit them prior to final approval.

So, plan ahead! You may have missed *Discover the Alamo* in 2006. If you did, there will be *Discoverys in the Desert* in 2007. Then we'll have ????? in the Southeast in 2008. I hope to see you at all of them, but if that is not possible, hopefully we will see you at one of them! So mark your calendars and please don't pass up all the good times that we are planning for you!

Have safe travels, drive slower, save \$ and fuel and hope to see you soon. ❖

REGION REPORTS

Southeast Region

It's hard to believe that summer is gone and we must start thinking about escaping the cold of another winter. Sue and I have been busy attending rallies all summer. We just returned from a glorious week with the Florida Discovery Rolling Gators, at Grandfather Mountain outside Boone, North Carolina. What a fun group that chapter is! Everyone should have the privilege of attending a rally with them at least once. They really know how to enjoy life.

by Dick Smith



We are getting ready for the last one of the summer with the Mason-Dixon Discoverys at Virginia Beach, Virginia. This is our 'home' chapter and we really look forward to rallying with the chapter members.

I extend a big welcome to all the new DOAI members who have joined since our last issue of *Discovery EXPRESS*. I look forward to meeting all of you, and especially those of you in the Southeast Region. I urge you to get involved; take part in every aspect of DOAI. The real fun is down at the chapter level. We have three great chapters in the southeast, and are trying to form another chapter to replace the one we lost. I

Continued on the next page...

REGION REPORTS, CONTINUED

recommend the Mason-Dixon chapter for those in North Carolina, Virginia, West Virginia, Maryland, Delaware, Pennsylvania, and New Jersey. The Florida Discovery Rolling Gators was set up for Florida residents and snowbirds, and the Dixie Travelers covers Mississippi and Alabama. We are going to form the new chapter to serve South Carolina, Georgia, Tennessee, and Kentucky. Get in touch with the chapter president of any chapter (see page 7) and he or she will sign you up. Or, get in touch with me and I will see that your request gets to the proper person (again, see page 7).



Our next big rally will be the Southeast Region rally at Lazydays RallyPark in Seffner, Florida, February 13-17, 2007. The registration form is on page 20 of this issue.

The Mason-Dixon chapter, with a little help from our friends, is ready to put on a first class rally for you at Lazydays. I urge you to register early and make your plans

for a good time.

We were able to secure just 150 sites, and I believe they will fill quickly, so don't be left out. Register early!

I need a favor from every DOAI member in the Southeast Region: I have many e-mail addresses that are not valid. I have

established an address database so that I can stay in touch with all of you and keep you informed of happenings between the quarterly issues of *Discovery EXPRESS*. If you would, take the time to sit down at the computer and send me a note with your correct e-mail address (mine is listed on page 7). I would certainly appreciate it.

Remember: sign up early for the *Sun-N-Fun* rally at Lazydays RallyPark, February 13-17. C'mon down, get away from Old Man Winter for a few days or weeks, and have a very good time. See you on down the road! ❖

Northeast Region

by John Zidek

We recently returned from Maine and are preparing to depart for the San Antonio rally, as I write this. The heat wave has finally broken in the northeast, and the weather has improved. Fuel prices have gone down some, however I don't believe they will ever return to the levels we have seen in the past. Still, the cost of travel in an RV is reasonable when compared to auto and air travel and the associated hassle of hotels and airports.

We look forward to seeing many of our members and friends at the Texas rally. Safe travels and good health to all! ❖



FEEDING THE RVER

by Nina Lee Soltwedel

My plea for recipes in the last issue resulted in several tasty submissions. I thank **Barbara Nelson** and **Vie Brock** for digging through their recipe boxes and forwarding the following:



LOW SUGAR FLUFFY PIE (Barbara Nelson)

Ingredients: Graham cracker crust, one regular size sugar-free gelatin mix, two 8 oz. containers flavored yogurt, one 8 oz. container non-dairy whipped topping.

How to: Mix gelatin powder with the yogurt. When well blended, fold in non-dairy whipped topping and pour into crust. Refrigerate until set.

Variations on a theme: Choose flavors of gelatin and yogurt that go together, such as black cherry and bing cherry, pineapple and piña colada, lime and key lime, etc. You can also place fresh or well-drained canned fruit in the crust before adding the filling.

FUDGE IN A FLASH (Barbara Nelson)

Ingredients: Two 8 oz. bags chocolate chips, one can sweetened condensed milk (Eagle Brand is recommended), one cup chopped pecans or walnuts.

How to: Mix chips and milk in a two-quart microwaveable bowl. Heat mixture for 30-40 seconds (650-watt microwave) until the chips are melted and the mixture is smooth and well mixed. Add nuts. Pour into a buttered 8" square pan. Refrigerate until set.

Variations on a theme: Substitute butterscotch chips, or part semi-sweet, or milk chocolate, or peanut butter chips for a different flavor.

SOUTHWESTERN SOUP (Vie Brock)

Ingredients: Two pounds bone-in chicken breasts, one 16 oz. medium salsa sauce, three cans great northern beans (undrained), two teaspoons ground cumin, one pound loaf Velveeta™ (cubed).

How to: Stew chicken until tender (about 30 minutes) and salt to taste. Cool, remove skin and bone, and chop meat into bite-size pieces. Strain chicken broth and set aside three cups. Combine beans, chicken, chicken broth, salsa, and cumin. Simmer for 30 minutes. Add cubed Velveeta™ and simmer another 30 minutes.

Variations on a theme: Vie simplified this recipe by using canned chicken broth and precooked chicken breast meat cut up (she often cooks some up and keeps it in the freezer). She also uses a can or two of Cheddar cheese soup in place of the Velveeta™. The beans can be varied: try pinto or black beans. Fried or baked tortillas cut into strips make a nice topping, along with a dollop of sour cream and chopped cilantro for garnish and flavor. She adds: "Put all the ingredients in a slow cooker on low in the morning for a very tasty, hearty soup in the evening."

CROCK POT CAKE (Vie Brock)

Ingredients: Oval crock pot (oval works better than round), one can fruit pie filling, one box cake mix, 1/4 cup (a half-stick) butter, softened.

How to: Grease pot, turn on low. Spread pie filling on bottom. Mix cake mix and butter together well, spread on top of pie filling and pat down lightly. If desired, sprinkle 1/2 cup chopped nuts on top. Cover and cook on low three hours.

Variations on a theme: Try apple filling and pecan cake mix, or cherry with chocolate fudge. Any combo will be scrumptious! ❖

DOAI BOARD OF DIRECTORS

President

Phil Yovino, 210 Fairfield St, Shoreacres TX 77571-7331; 877.246.4271; pdyo@sbcglo bal.net

Executive Vice President

Tom Fields, 1758 Joy Spring, New Braunfels TX 78130-7709; 877.238.6955; thomfiel@earthlink.net

Vice President of Development

Marshall Godwin, 103 Riverview Cir, Colonial Beach VA 22443-4816; 877.246.4516; godwin.marshall@kingfishers ys.com

Secretary

Becky Godwin, 103 Riverview Cir, Colonial Beach VA 22443-4816; 877.851.9874; beckygodwin@msn.com

Treasurer

Micky Racer, 233 Rainbow Dr PMB 13396, Livingston TX 77399-0001; 877.245.9661; mimra@aol.com

National Rally Master

Jay Keneson, 404 Cypress Springs Dr, Spring Branch TX 78070-4640; 888.793.4793; jayk@gvtc.com

Past President

Bob Baugh, 123 Applecreek Ln, Richmond KY 40475-9154; 877.238.6952; rbaugh@ chapel.us

REGION VICE PRESIDENTS:

North Central (IL, IN, IA, KS, MI, MN, MO, NE, ND, SD, WI)

Dick Snyder, 411 Alexander Dr, Seymour IN 47274-8633; 877.282.0779; snyderflys @comcast.net

Northeast (CT, ME, MA, NH, NJ, NY, OH, PA, RI, VT, NB, NS, ON, QC, PE)

John Zidek, 82 Easy St, Cape May Court House NJ 08210-1329; 877.282.0776; jzidek @dandy.net

Northwest (AK, CO, ID, MT, OR, UT, WA, WY, AB, BC, MB, SK)

Bob Soltwedel, 4736 Harwich St, Boulder CO 80301-4217; 877.238.7095; bob.soltwedel@gmail.com

South Central (AR, LA, OK, TX)

Garry Shirey, 2450 Williams Lakeshore Dr, Kingsland TX 78639-4077; 877.245.9654; garryts@tstar.net

Southeast (AL, DE, FL, GA, KY, MD, MS, NC, SC, TN, VA, WV)

Dick Smith, 3000 Old Mountain Rd S, Joppa MD 21085-2910; 877.238.6953; poppop4171@msn.com

Southwest (AZ, CA, HI, NV, NM)

Gerald Embry, 14572 Mesa St, Hesperia CA 92345-2242; 877.238.6954; gembry@ verizon.net

DOAI CHAPTERS/PRESIDENTS

Arizona Discovery Owners (AZ)

Barbara Klusman, 10040 E. Ranch Gate Rd, Scottsdale AZ 85255-2306; 480.585.5599; cell 602.549.5590; klusman@msn.com

California Goodtimers (CA)

Gerald Embry, 14572 Mesa St, Hesperia CA 92345-2242; 760.947.6950; gembry@verizon.net

Discovery Pioneers (AZ, CO, KS, NE, NM, UT, WY)

Roger Talich, 1358 W Briarwood Ave, Littleton CO 80120-3631; 303.795.6023; cell 303.906.8735; rtalich@cs.com

Discovery Texans (TX)

John Baker, 2922 Colonel Court Dr, Richmond TX 77469-6702; 281.341.7177; baker john@swbell.net

Dixie Travelers (AL, MS, GA, FL)

Howard Taylor, 8047 Ansley Trace, Montgomery AL 36117-8218; 334.356.9052; cell 334.318.5552; htaylor7@wmconnect.com

Florida Discovery Rolling Gators (FL)

Tom Ebbert, PO Box 1134, Tavernier FL 33070-1134; 305.852.9762; cell 305.393.1215; quiltz4u@bellsouth.net

Heartland Discoverys (IL, IN, IA, KS, MI, MN, MO, NE, ND, SD, WI)

Elfers Marzahl, 3905 Lake St, Burlington WI 53105-7722; 262.763.6741; elfers@pngusa.net

Louisiana Mudbugs (LA)

Carolyn Barnes, 715 Stable Rd, Ruston LA 71270-3069; 318.251.2568; crb39@cox-internet.com

Mason-Dixon Discoverys (DE, MD, NJ, NC, PA, VA, WV)

Tony Faverio, 1226 Shipyard Rd, Shenandoah VA 22849-5406; 540.652.1042; cell 540.421.3928; tony.faverio@gngplc.com

Midwest Discoverers (IN, KY, OH, PA)

John Wimer, PO Box 42, Hammondsville OH 43930-0042; 330.532.3031; john.wimer@att.net

Nor'easters (CT, ME, MA, NH, NJ, NY, OH, PA, RI, VT, NB, QC, ON)

Dorie Baker, Cypress Woods RV Resort Lot B-99, 5551 Lucket Rd, Fort Myers FL 33905-5509; 717.487.8879; dorieann@aol.com

Northwest Adventurers (AK, ID, MT, WA, AB, BC, MB, SK)

Ken Swain, 1446 Forge Way, Draper UT 84020-8834; 425.802.3240; eagle747@earthlink.net

Texas Disco Road Runners (TX)

Garry Shirey, 2540 Williams Lakeshore Dr, Kingsland TX 78639-4077; 325.388.4746; garryts@tstar.net

HELPFUL RV CONTACT INFORMATION

Allison Transmission, GM Corp.	800.252.5283	Kwikie Products	800.736.9961
Atwood Mobile Products	574.264.2131	Magnadyne	800.638.3600
Caterpillar RV Engine Support	877.777.3126	Michelin North America	800.847.3435
Carefree of Colorado	800.621.2617	Norcold, Inc.	800.543.1219
Carriage Carpets (Shaw Flooring)	877.706.3054	Onan	800.888.6626
CCI Controls	800.521.5228	Power Gear	800.334.4712
Cummins, Inc.	800.343.7357	Riverpark	800.442.7717
Denso (call Fleetwood)	800.322.8216	RV Dump Locations	www.rvdumps.com
Dometic Corporation	800.544.4881	RVP (Coleman)	316.832.4357
Fantastic Vent	800.521.0298	RVP (Suburban)	423.775.2131
Fleetwood RV	800.322.8216	Splendide	800.356.0766
Freightliner Chassis Corp	800.385.4357	Thetford Corp.	800.521.3032
General Electric	www.geappliancs.com/geac/	Trojan Battery Company	www.trojanbattery.com
Goodyear Tire & Rubber	800.321.2136	Velvac	800.783.8871
Intellitec	800.251.2408	Winegard	800.288.8094
Kidde Safety Products	800.880.6788	Xantrex Technology	800.670.0707

CHAPTER REPORTS

Discovery Pioneers

Since my tightly contested election to the office of President of the Discovery Pioneers has transpired, I have begun to ponder the duties of this office. Based upon my initial impression, it appears to be the job that I always wanted during my so-called working years. I am not required to get up in the morning and go to the office and as near as I can tell the duties do not involve long hours. Since we have not yet had an outing during my term in office, there seems to be little to report upon and therefore (aside from writing these articles) there seems to be little for which I can be criticized.

This is all about to change, however. The Discovery Pioneers have a rally that promises several enjoyable activities in Chama, New Mexico. The rally is to run from September 12 to September 17. Aside from the daily happy hours, the highlight of the outing should be a day-long train ride though some of the more scenic areas of the San Juan mountain range of northern New Mexico into southern Colorado. The steam train trip should evoke memories in many of an earlier time when our country was still expanding from shore to shore.

It appears that our hosts have done a marvelous job in putting together what promises to be a grand rally. Congratulations to Bob and Nina Soltwedel and Carl and Marge Ropp for a job well done in arranging this rally.

Following the Chama rally, several of our group plan on attending the national rally in San Antonio and then continuing to our winter homes in various places where snow generally does not fall. Since the end of the season is upon us, it is time to thank everyone who participated in our rallies and encourage all to submit ideas for outings during the next camping season. Thank you all and we are looking forward to seeing you in Chama, San Antonio, or one of next year's rallies. ❖

Arizona Discovery Owners

The chapter gathered at Munds Park RV Resort in the cool pines just south of Flagstaff last August, enjoying the fellowship with old friends, meeting new ones and enjoying the beautiful weather. Eight coaches were present, two of which were new members. A warm welcome to Bill and Kathy Blackman, and Max and Sandy Grigg. We look forward to having you as chapter members!

Our activities began early (6a.m.) on Saturday with some members flying RC planes and others as spectators. Afterward, we gathered for breakfast at the local Lone Pines then on to the Snow Bowl for the scenic ski lift ride for those courageous RVers. Some of us enjoyed the view from

by Roger Talich



ground level. The evening came to a close with dinner at the local country club.

A delicious waffle breakfast was prepared by our rally hosts, Ed and Geri Cozens. What a wonderful way to jump start our day. Our athletic members joined together for a three-mile hike. Sunday's steak fry found Carl May at the grill preparing the evening meal for all to enjoy. To complete a successful rally, we had another unsuccessful chance to unseat record-holder Joe Eisenman in playing Mexican Train. We will keep trying!

The last morning we all gathered for breakfast, to say our good-byes and put miles behind us and make plans for our next rally. Our next rally is November 30-Dec 3 in Yuma, AZ, hosted by Chuck and Judy Osborn. With regrets, we said good-bye to charter members Bud and Joan Munzer. You will be missed and will always be affectionally thought of as Discovery alumni. ❖

Northwest Adventurers

by Ken Swain

The Northwest Adventurers will have a short rally after the national rally in San Antonio. Make your own reservations for the Albuquerque Balloon Festival. We'll be there Wednesday, October 11 through Saturday, October 14.

Our annual winter rally will again be held in Blythe, California, for the Blue Grass Festival. Please let me know if you are interested in attending and we'll get the information to you. We'll also be e-mailing all members who have an e-mail address on record. I still have a spam blocker on my e-mail, so just put "Discovery" in the subject line and I will pick it out and add you to my address list.

Drive safely and we'll see you in San Antonio. Plan on a chapter meeting at that time and elect new officers. ❖

Heartland Discoverys

by Elfers Marzahl

This has been a fast-paced summer, and fall is approaching quickly. Our chapter members are looking forward to our Texas pre-rally and the national rally in San Antonio. We welcome new members Terry and Sherry Klungseth from Minnesota. We all look forward to meeting you at our rallies.

Heartland Discoverys members have had some great get-togethers, and are looking for more fun in 2007. We have 24 coaches in our club at this time, and everyone sure makes a great group to know. Many members from all chapters will be heading to their pleasant winter retreats. We wish them all safe travels. Remember to check the DOAI Web site for updates on chapter events. ❖



...had this view going down!

by Wanda May



President Barb



Those who went up the lift...

CHAPTER REPORTS, CONTINUED

California Goodtimers

by Gerald Embry

As an update to my report in the summer issue of this newsletter, we now have 29 members and two or three good prospects.

Our first California Goodtimers rally will take place September 12-15 at the Elks Lodge in Lancaster, California. We will have a good attendance in view of the fact that we had to rush things in order to squeeze in a rally before year end.

We have interim officers in place and will schedule rallies for 2007. We will plan for a rally to be held early in the year, at which time we will elect permanent officers.

Hope to see you in San Antonio! ❖



The Mudbugs in Livingston having fun!

Back row, L to R: Anita Scott, Johnny Gros, Anne Gros, Howard Campbell, Mary Campbell, Mac McIlvaine, Jan McIlvaine, Shirley Farnsworth, Wayne Farnsworth, Keith Barnes.

Front row, L to R: Buddy Sykes, Evelyn Sykes, Iola Ennis, Ben Ennis, Carolyn Barnes, Cathy Verdin, Anthony Verdin.

Mason-Dixon Discoverys

by Tony Faverio

The Mason-Dixon Discoverys are gathering for an end-of-summer rally at Indian Cove Resort in Virginia Beach, Virginia on September 14 for four-five days, or longer. We have planned a relaxing escape to the beach in the off-season; time to allow us to enjoy the sights and sounds of the ocean and the charm of local festivals including the annual Neptune Fest. We will enjoy sightseeing, fishing, shopping and simple relaxation at the 'Cove.' At the end of the rally, our wagon master, Richard Smith, will lead a caravan of Discoverys to San Antonio, Texas.

Please keep Alan and Arlene Richie in your prayers, Arlene is undergoing chemotherapy at this time.

The Mason-Dixon Discoverys will be hosting the DOAI Southeast Region *Sun-N-Fun* rally to be held February 13-17, 2007, at Lazydays RallyPark in Seffner, Florida. Registration form and details can be found in this issue (pages 4 and 20) and on the DOAI Web site. Book early! We have 150 sites reserved. This is a wonderful time of the year to be in the warm sun of Florida and enjoy the camaraderie of other Discovery owners.

Best wishes for good health and safe travels. ❖



Louisiana Mudbugs

by Anne Gros

The August heat couldn't stop the Louisiana Mudbugs from enjoying the rally on August 11-12 in Livingston, Louisiana. Rally hosts Anita Scott from Baton Rouge and Evelyn and Buddy Sykes from Abita Springs did a great job with potluck on Friday and a jambalaya supper on Saturday.

Nine coaches from around the state met for the weekend. Our newest members, Cathy and Anthony Verdin from Marrero, enjoyed the fellowship and camaraderie of our club.

Co-hosting the San Antonio rally in October was discussed and plans were made for several members to meet in Houston to caravan to San Antonio.

A Cajun country rally in November is planned at Frenchman's Wilderness located in Butte LaRose near



President Carolyn

Lafayette on November 2-5.

Anyone interested in joining the Mudbugs may contact Carolyn Barnes (see page 7). ❖

Discovery Texans

by Elsie Sikes

Our chapter members spent the summer all over the world! **David and Ginger Blomstrom** didn't drive their rig there, but took a trip to Russia which included a cruise from Moscow to St. Petersburg. Our Aussie members, **Rod Kirk and Pauline Allen** returned to North America, picked up their rig, and toured the eastern seaboard, into Canada. Our newest members, **Richard and Janet Blakeley** discovered the joys of RVing when they took their shakedown cruise journey to Lubbock in the Discovery they inherited from Richard's father, experiencing a front tire blow-out and other mechanical problems.

Beth and Art Schmidt spent the summer in Glacier, Kootenay, Banff, Jasper, and Yoho national parks, and central British Columbia. **Chuck and Dot Smith** hosted a reunion in Crockett for Houston retired police officers with over 200 folks. **Bob and Vicky Hogue** moved to a wildlife preserve at Indian Springs near the Bexar/Comal county line in the Texas Hill Country. **Joyce Bednarczyk** worked at Las Aves RV Park in Medina until it closed at the end of August, then relocated to work at the Pioneer RV Park in Bandera.

Jackie and Della Quinn made a trip to Yellowstone. **Frank and Gene Sawyer** moved into a new home in Frankston after a bit of remodeling. **Tom and Sandy Fields** trekked to Alabama for a grandson's graduation and visited with **Jim and Dorothy Devine**. **Pete and Martha Palasota** traveled to Canada. **Al and Julie McKinstry** spent the summer working on their future home in Pipe Creek.

Joe and Justine Stewart volunteered at Detroit Lakes State Park, 50 miles east of Salem, after a few stops in Arizona and Nevada. **Leroy and Gwen Churchill** and **Wilma and Herb Stark** made separate trips to Alaska, and their paths crossed. **Leon and Elsie Sikes** spent the summer in western Maryland and Virginia visiting family, and volunteering at the Chesapeake and Ohio National Historical Park near Washington, D.C. ❖



President John

NEW MEMBERS



We welcome our newest members, those who joined DOAI since the last issue of this newsletter. Be sure to extend the hand of welcome when you meet them.

Jerry Grace, Spanish Fort AL
Joseph Barness, Land O'Lakes FL
Rhoda Turk, Barnegat NJ
Truman Brinkley, Groves TX
Ian Bieszad, Thonotosassa FL
Jeffrey Price, Lake Helen FL
Cris Castles, Pompano Beach FL
Jose Rodriguez, Groveland FL
William Kane, Palatka FL
Stephen Geiger, Ft Lauderdale FL
Allison Russo, New Port Richey FL
John/Alyce Agostinella, Venetia PA
David/Linda Berry, Pensacola FL
Emroy/Jean Biteler, Marshall MN

Gary/Joann Blackwood, Bremerton WA
Jack/Linda Brown, Denver CO
Frank/Isabel Cason, Chuckey TN
James/Nancy Copeland, Kingston OK
Walter/Jan Hare, Franklin NC
Bob/Mandy La Plante, Jacksonville FL
Milton/Darlene Livingston, Rapid City SD
Bill/Jan Maietta, Hollywood FL
Louis/Becky Martin, Tallahassee FL
Walter/Karen McKnight, Bandera TX
Don/Sherry Neil, Huntersville NC
Ken/Lorraine Randlett, Laconia NH
Roger/Sonya Bickers, Pickering, ON Canada
Anthony/Catherine Verdin, Marrero LA
Carl/Ronda Crook, Whitehouse Station NJ
Robert/Violet Radd, Warrenton VA
Frank/Vickie Bernard, Wimauma FL
Edward/Libba Gruba, Loganville GA
David/Paula Peretti, Olympia WA
Steven/Lori Parrino, Staten Island NY
Larry Ward, Homestead FL
Bill/Joyce Walls, Hominy OK
Dan/Jann Miller, Turlock CA
Robert/Joann Wilkins, New Knoxville OH
John/Sharon Sanders, Lowell IN

Raymond/Renee Lillie, Pensacola FL
George/Joan Lindsay, Vancouver WA
Rick/Donna Garis, Aurora OR
Bob/Fran Pitts, Palos Verdes Peninsula
CARussell/Susie Hudson, Novato CA
Joel/Linda Landavazo, Sanford NC
Bill/Anne Nissley, Covina CA
Andy/Billie Kennedy, Delhi, ON, Canada
Gregg/Marsha Falkenberg, Willernie MN
Ted/Judy Harris, Sonora CA
Lenny/Shelley Veary, Lake Havasu City AZ
Roger/Kristine Jacobsen, South Elgin IL
Mark/Marilyn Segars, Turlock CA
David/Mary Smoot, Cynthiana KY
James/Judith White, Apple Valley CA
Peter/Margy Olney, Mill Creek WA
Beverly/Laurence Kaiser, Richmond MI
Paul/Cynthia Martin, Pomfret Ctr CT
Barry/Mary Carol Litman, Uniontown PA
Ronald Speckhart, Wallingford CT
Leo DeBandi, Riverview FL
Paul Merrill, Arlington TX
Lindsay Dunkley, Miami Lakes FL
Ronald/Rozann Adas, Port St Lucie FL
Dale/Judith O'Daniel, Marianna FL ❖

DOAI MEMBERSHIP SPONSORS

Heartfelt thanks are extended to these Fleetwood dealers who support DOAI by paying for the first year's membership for each person who purchases a new or used *Discovery* motor home.

COLORADO RV OUTLET, GOLDEN CO

DEMONTROND RV, HOUSTON TX

HAYES RV CENTER, LONGVIEW TX

K&C RV, LONGMONT CO

K&C RV CENTER, COLORADO SPRINGS CO

LAZYDAYS RV CENTER, SEFFNER FL

RCD SALES COMPANY LTD., HEBRON OH

REINES RV CENTER, MANASSAS VA

VALLEY RV CENTER, McMINNVILLE OR

*DOAI and Fleetwood dealers –
sharing the spirit of friendship!*



RV VIDEOCASTS VIA INTERNET ANNOUNCED

American RVer announces the launch of its free video podcast, the first of its kind in the industry.

On April 15, 2006, the first in a long-running series of monthly video casts highlighting the RV industry, its people, and travel destinations was available for download for free on everyone's personal computer, Mac or PC, for iPod, or other hand-held audio or video device. Each show, less than a half-hour in length, will be spotlighted on the Web site americanrver.com.

The videocasts highlight topics of interest to RV owners including technical tips, cooking and healthy living tips, travel logs, and campground highlights as well as interviews of campers met along the way.

The first show includes a review of the Shallotte/Brunswick Beaches KOA Campground in Sunset Beach, North Carolina, how to grow herbs in an RV, and how to care for the interior wood and solid surface counters in the RV, along with camper interviews. A recent trip to The Rally in Daytona Beach, Florida is one of the focal points of the second and third "webisodes." A trip to a winery highlights show number four. Each show is available in either a video or audio-only format.

The TV-style production is only one part of the Web site. A travel log highlights the Grich's most recent travel destinations, American RVer products will be available for purchase, and industry sponsorships will allow visitors to go directly to RV-related businesses. Previous webisodes are also available for download from the Web site.

Owners Jim and Peggy Grich are full-time RVers and have selected the Internet as the perfect place to launch this new project. As they travel in their 40-foot Monaco Camelot, their adventures include stops at wineries, tourist destinations, and local hot spots. Interviews with other campers in their "Friends Across America" segment add spice to the show and highlight the relaxed atmosphere of this unique lifestyle. Shows typically run from 15 to 23 minutes.

The Griches have been in the television and video production industry for over 30 years, formerly owning a television station and currently owning American Imaging, a video production company. In addition, Jim has been the webmaster for his company Web.Lync for the past 12 years and has produced hundreds of Web sites for businesses.

To view an episode, visit americanrver.com or go to the Apple iTunes Web site and search for RV in the travel section of the podcasts. ❖

DISCOVERY MODIFICATIONS, CHAPTER 7

In the Summer 2004 issue of this newsletter, several of Pete Shaffer's modifications to his 'Big D' (as he affectionately calls her) were pictured, but without lengthy explanations. Because not all our members have Internet access, Pete's instructions for creating the 'Big Sofa Drawer' are detailed here. If you have any questions about this project, please contact Pete at pshaffer@kih.net.

BIG SOFA DRAWER

by Pete Shaffer

This is not my idea, just my version of the idea. I looked at others that were built, saw what I perceived as problems and tried to modify mine to improve on the ideas.

Dimensions are all controlled by the sofa support frame. Yours may be different than mine so "measure twice and cut once" (my father's favorite saying). I rough cut the bottom a little bit on the large size and temporarily "made" my drawer by screwing the parts together without the glue. That way I could finish cut the parts after I got all the angle brackets, and drawer slides attached.

My finished drawer is: 68¾ inches wide (out to out); 29¾ inches deep (out to out) plus ½ inch for the sofa front; and 5¼ inches tall (out to out). I used ¾-inch plywood for the bottom, and ¾-inch plywood for the sides. Drawer tracks or slides are 3 slides (2 on sides and 1 bottom center, you have to buy 2 sets) of 24-inch KV 8400, 100 pound, ball bearing steel units purchased at Home Depot. **Note:** you could substitute a wood center slide for the ball bearing one I used, only the wooden one is taller, and will reduce the overall drawer height.

Clearances

Sides: 1 inch from drawer outside to the vertical 1-inch by 1-inch steel sofa support bolt head. This gave me enough clearance for the right angle bracket plus the drawer slides.

Top: ¾-inch clearance between the front horizontal 1-inch by 1-inch steel sofa bar and the drawer top edge.

Bottom: ¾ inch off the floor. This is enough to allow for the center drawer slide and allow the drawer to "float" above the carpet.

Seatbelt shelf: This is approximately 11 inches above the floor. I used furring strips on the back wall, so the seatbelt shelf rests and is screwed to the furring strips. It is resting on the horizontal 1-inch by 1-inch black steel sofa support bar that is at the rear of the sofa.

How I Did It

I removed the sofa from the floor support by unbolting the sofa and leaving the sofa floor support in place. The angles are 3 inches by 3 inches and rest under the sofa steel bar that is bolted to the floor. I removed the bolt, drilled a hole in the angles, inserted the angles under the bar and bolted the support back into place. I then bolted the drawer slides to the angles making sure they were parallel to the floor, and parallel to its mate on the opposite side. Then I sat the drawer in between the drawer slides and made final adjustments by cutting the plywood floor or using washers to shim the drawer slides. This took a lot of time but was worth it. Once the drawer slid smoothly in and out, then I sat the sofa on the steel supports and checked for drawer clearance. Only after everything checked out did I disassemble everything one more time and

glue the wood drawer together and install screws. I like to use drywall screws and drill pilot holes to keep the wood from splitting. Sand the finished drawer, prime and paint any color you want.

The covered sofa side pieces that were attached to the front sofa panel are now screwed to the dinette and room walls. The covered/padded front had to be uncovered and trimmed about ¾ inch so it would slip under the sofa and still be slightly above the carpet. I modified a decorative deadbolt type hardware so I could attach the dead bolt to the inside of the drawer, but slide the bolt up and down from the outside of the drawer.

Photo Gallery

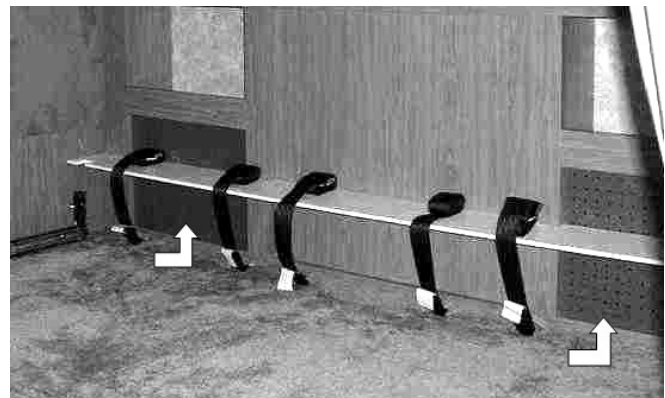

Photo 1

Photo 1 is the **seatbelt shelf**. It holds the belts and keeps things from falling down behind the sofa and blocking the drawer from closing. The inside edge is screwed to a furring strip and the outside edge of the shelf rests on the horizontal bar of the sofa. Also, in this photo, you can see the expanded storage space behind the sofa. I opened the area below the two inset shelves and covered the openings with pegboard. That will allow for ventilation, and they are not visible once the sofa is reinstalled. Access to this area is achieved by removing the bottom of the inset shelf. The seatbelt webs are fed through slots cut into the center of the shelf. I cut the slots narrow to keep the belts from sliding down.

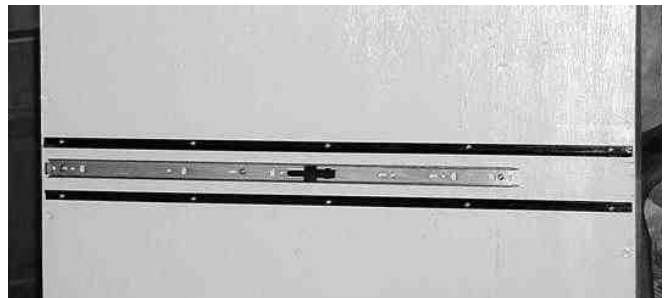

Photo 2

Photo 2 shows the **three drawer slides** I used. The side tracks are mounted on 3-inch angles that are set under the sofa supports. The center track is to keep the drawer from wobbling when closing. With a drawer this wide, there is a tendency for it to wobble from side to side when opening or closing. The track also helps keep the drawer from sagging in the middle when the drawer is fully loaded. The center track was modified

Continued on the next page...

DISCOVERY MODIFICATIONS, CONTINUED

slightly to allow it to slide completely apart without pressing the plastic stop tab. Side drawer tracks still have the stop tab, and it is necessary to press the tab before they will come apart for drawer removal.

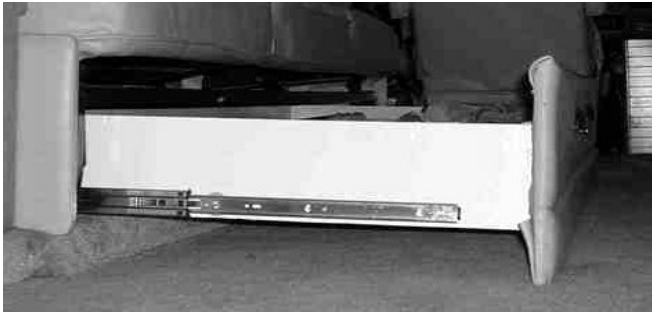

Photo 3

Photo 3 shows the **bottom of the drawer**. Attached in the center is the other half of the center slide. I removed the slide full-open stop mechanism so that I could remove the drawer without reaching under the drawer to trip the full-open lock mechanism. The side drawer slides retain their full-open locks. On either side of the center track are 1/2-inch by 1/2-inch angle irons to help support the bottom of the drawer and to keep it from bowing. The face board is set 1/4 inch from the floor and will keep the drawer from tipping downward when fully open and loaded.

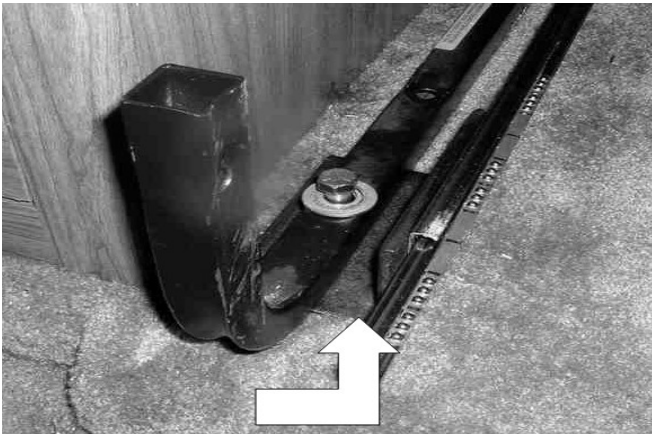

Photo 4

Photo 4 is a close-up of the **angle** supporting the drawer slide. Note the angle is under the sofa support leg with bolt going through the angle.

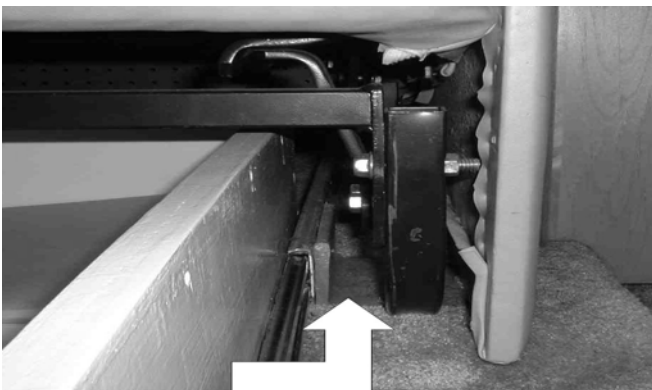

Photo 5

Photo 5 shows an **angle support** with drawer installed.

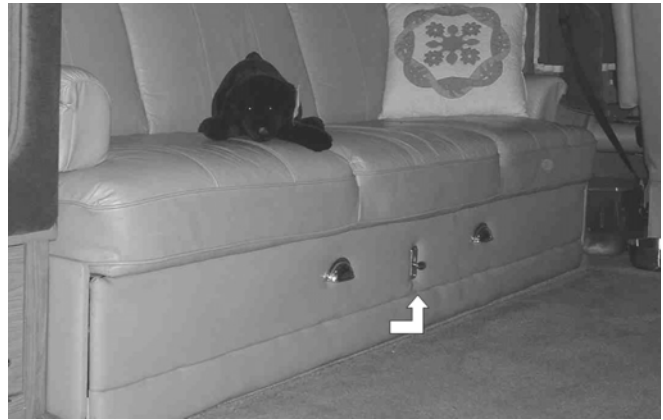

Photo 6

Photo 6 is of the **front of the sofa**. The center item on the front of the drawer is a the locking slide to prevent drawer from opening while in motion.



Photo 7

Photo 7 shows the **inside of the drawer**, focusing on the sliding lock mechanism. ❖

COLD WEATHER CAMPING TIP

by Mark Polk

Always keep carbon monoxide poisoning in mind during cold weather camping. You cannot see it, taste it, or smell it. Never use the range burners or oven as a source of heat. If your RV did not come equipped with a carbon monoxide detector, you should purchase a battery-operated model designed for use in RVs. You never know when you will be parked in close quarters with another RV running a generator. Always test your carbon monoxide detector for proper operation before leaving on a trip. For more information about carbon monoxide poisoning, go to www.carbonmonoxidekills.com

LADIES – TIME TO WINTERIZE THE RV

by Donna Flanders

Oh no...not another article about winterizing. Yes, indeed. And ladies, it's your turn. It always surprises me that most articles about how to winterize the RV stop shortly after the water and electrical systems. What about all the things you have stored inside? There's a lot more to be done if your rig is going to sit for several months at temperatures below freezing.



Harvey and Donna Flanders

The rules of thumb:

If it contains water – take it out.

If it will attract rodents – take it out

If it has an expiration date – take it out

If you're not sure – take it out. Think "Do I want to replace this item or clean it up if it does not survive the winter?"

Let's start in the kitchen. Go through your food cupboard, under the kitchen sink and any other place where you tuck things. Look for things like:

Jars of food

Beverages

Bottled water

Cleaning products (sprays contain water)

Any food that will attract rodents or expire

Paper towels and napkins that rodents use for nesting

To keep your refrigerator smelling clean and free of mold, place pure charcoal (not charcoal that contains fire lighter) on pieces of newspaper on a shelf inside the refrigerator and freezer.

Moving on to the bathroom. Let me tell you that a can of shaving cream which has been frozen will never be the same. When water freezes, it separates from the other ingredients. Don't forget to check under the bathroom sink.

Toothpaste

Shaving cream

Liquid makeup

Face, hand and medicinal creams

Anything with an expiration date

Toilet paper and tissues that rodents use for nesting

Head to the bedroom. Check your bedside drawers. Do you have any hand cream or other health and beauty aids in there? Do you have an iron with a water reservoir? Is there anything in the closet that you will need over the winter? To keep bed linens and towels smelling clean, place them inside a large plastic container with a tight fitting lid. Add dryer sheets.

I rarely find anything in the living room or front of the RV, but since your rig is different from mine, check anyway.

We have a chronic problem with mice, perhaps because we live in the woods. Regardless of how hard we have tried to plug every hole, they still find a way in. They routinely get into my silverware and utensil drawers during the winter months. So I actually take those drawers right out as well.

Now you are ready to shampoo the rugs and remove any stains from furniture. If you let this wait until spring, the stains will be much harder to get out.

OK. Now you have all this stuff out of the RV. What do you do with it? I generally circulate the food and health products into my household supplies because they have expiration dates. Then, I got my husband to build shelves in the basement and I store everything else in boxes.

Keeping the shelves empty during the summer is the challenge. I try to keep the empty boxes on the shelves to remind myself not to use that storage space for anything else.

Last but not least, have someone else go through the cupboards after you are done. I missed a whole gallon of bottled water last year. I do wonder where all that water went because it wasn't in the jug when I found it! ❖

Donna and Harvey Flanders have been camping for over 20 years, the past nine years in a Fleetwood Bounder motor home. After a five-month trip from New Hampshire to Alaska, Donna began her RV vacation planning business, which includes an itinerary with sunny and rainy day activities, trip routing, campground list based on your RV size and hook-up preferences, and more. For details, go to www.rvvacationplanner.com.

A "FUEL-ISH" QUESTION AND A COMPREHENSIVE ANSWER

DOAI member Kurt Klebe, having learned from the media about the new low sulfur diesel fuels now being marketed, wrote to Cummins last May with the following question:

"I have a Cummins 275 ISB engine in my 2000 [Discovery] motor home. I would imagine the engine is from 1999. My question is, will I need to upgrade anything so my engine will run on the new low sulfur diesel fuels coming out later this year?"

Cummins responded to Kurt, and DOAI has received permission from Cummins to publish its response:

"Today, the sulfur content of ULSD ranges from 15 to 30 parts per million. Regular diesel has a maximum of 500 parts per million of sulfur.

"U.S. Environmental Protection Agency (EPA) rules

require that new diesel engines meet lower emission levels beginning in 2007 and will require ultra-low sulfur fuels for all on-road engines beginning in 2006. Other than the sulfur content, ultra-low sulfur diesel generally meets the same specifications as regular on-highway diesel. Starting in 2006, the majority of highway-grade diesel fuel must be ULSD and have no greater than 15 ppm sulfur level at the pump.

There are many rumors circulating about the effects of sulfur being in diesel fuel or sulfur being taken out of diesel fuel. Ultra-low sulfur diesel fuel is a specially refined diesel fuel that has dramatically lower sulfur content than regular on-highway diesel and can be used in any diesel engine just like regular on-highway diesel fuel.

Diesel fuel, in the United States, must meet a lubricity standard. The producers adjust the lubricity of the ultra-low fuel before they distribute it to truck stops and other selling

Continued on the next page...

FUEL-ISH QUESTION, CONTINUED

points. No further additives should be needed to ensure proper fuel system lubrication.

Using ultra-low sulfur diesel will contribute to dramatic reductions in diesel emissions.

The lower sulfur content produces fewer sulfate emissions and, most importantly, enables use of emission-reduction equipment, like particulate traps and catalytic converters to lower emissions of particles and nitrogen oxides. Use of these systems in combination with ultra-low sulfur diesel can reduce emissions of fine particulates by more than 90 percent and emissions of hydrocarbons to nearly undetectable levels.

Even without special emission-reduction equipment, use of ultra-low sulfur diesel in diesel engines reduces sulfate pollutants. It also has some benefits by lowering engine maintenance costs.

Ultra-low sulfur diesel fuel is expected to have virtually the same energy and performance as today's highway diesel.

Cleaner ULSD will cost more than current highway diesel

fuel. EPA estimates that it will cost consumers several cents per gallon at the pump, when it is required on a widespread basis. Until then, predicting the actual cost impacts is highly uncertain.

Converting to ultra-low sulfur diesel fuel is simple. ULSD doesn't require any special storage systems, and is stored in the same kinds of storage tanks and fueling systems of today's diesel fuel.

ULSD is already available in some parts of the country on a limited basis, mostly to fleet purchasers, but at some service stations in California. Many transit and school bus fleets around the country have converted to using cleaner ULSD in their existing operations. For an up-to-date map showing where ULSD is available go to www.epa.gov/otaq/retrofit/fuelsmap.htm ❖



Editor's Note: We extend thanks to Kurt for sending the information so that all DOAI members can benefit from Cummins' response.

KEEPING IN TOUCH ON THE ROAD WITH WI-FI

by Carol White

One of the most discussed topics on travel forums these days is 'staying in touch.' Of course, the advent of e-mail and the Internet has revolutionized the way we communicate and gain information in today's world, but sometimes figuring out the best way when you are traveling is still a bit confusing. One of the newest and best ways to stay in touch is with Wi-Fi...when you can find it.



Phil and Carol White

Wi-Fi is short for wireless fidelity and is quickly becoming the mobile standard. 'Hot spots,' both complimentary and paid, are cropping up all over the country in places both urban and remote.

In fact, entire cities are beginning to deploy Wi-Fi in a 'mesh' configuration throughout so that all the citizens can have access to this easy to use, fast way of communicating.

Of course, nothing is really free. What this means is that someone has paid to install the service in their home or business and is offering you the ability to access their service without charge. You most often find these public hot spots in retail locations or government provided locations such as libraries. The business providing the service generally does this as a convenience while you are using their hotel, campground or coffee shop.

If you happen to find access near someone's home or office, these are not really meant to be public hot spots and you should use discretion and ask permission before 'hopping on' someone's personal service.

Paid services are frequently found in airports, some businesses, citywide services and those provided for a company's subscribers, like the network developed by SBC/AT&T for their clients. The rates for accessing these systems vary widely from hourly charges to subscription services, depending upon the vendor's agreement.

Using Wi-Fi is quite simple. Most new portable computers have the necessary hardware and software needed to find the Wi-Fi signals in an area. Many older computers can also be retrofitted with a Wi-Fi card, which generally fits into a PCMCIA slot. Once one or more signals are detected by your device, you select the strongest, most appropriate one and connect to it. The software will tell you whether a signal is 'unsecure' (complimentary to the public) or 'secure' (provided at a charge or unavailable for public use).

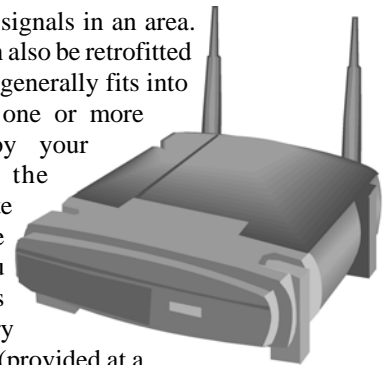

Once connected, you can access all your online accounts including e-mail and your personal travel Web site. It's simple, reliable and fast to upload those latest pictures and stories so your friends and family back home can see what you're up to today. ❖

Carol White is co-author of award-winning Live Your Road Trip Dream and can be found online at www.roadtripdream.com. Editor's Note: DOAI's Web site contains a listing of 600 sites across the country that provide Wi-Fi free of charge. The file can be downloaded to your computer and printed out, making it easy for you to take it with you as you leave home.

EGROUP CONVERSATION

Not every DOAI member participates in the eGroup. In an effort to share helpful information from the eGroup, occasionally we will publish a conversation which may be of assistance to non-group members. This time we feature a compilation of several questions about exhaust brakes and brake lights. Several DOAI members collaborated on this article, and none wish to be named. Gene Hamelman created the drawing from those individuals' input.

SUPPLEMENTAL EXHAUST BRAKING

The question: Recently I installed the SMI system and it functions as described in the literature. However, the unit fires off the brake signal from the coach. Therefore, when the exhaust brake is engaged (brake lights come on), so is the SMI unit in the tow vehicle. I would like to install a single pole switch to interrupt that signal when towing. Where will I find that signal wire?

The answer: We have an SMI brake system for our tow, and we love it. Generally, our brake unit will not apply the tow's brakes if the exhaust brakes only are applied, but that's simply a matter of adjusting the accelerometer angle on the SMI so that it's less sensitive. Sometime back an article on the DOAI Web site discussed how a member modified his coach so that the cruise control would not turn off when the exhaust brakes came on. That was effectively done by preventing the coach brake lights from coming on when the exhaust brakes were activated. That same simple modification, or something like it, would answer your question.

We modified our exhaust brakes in a manner which has worked extremely well for us. With an additional switch in the 'on' position, our exhaust brakes are automatically applied every time we hit the brake pedal. Effectively what happens is that, when we apply our brakes, a two-pole relay acts to duplicate the action of turning the exhaust brake switch on. That means, in the event of an emergency braking situation, the

driver is not required to take his or her hand off the {tightly gripped} steering wheel and grope for that exhaust brake switch. It's perhaps the best simple modification we've made to our coach. On at least two occasions, with an unexpected deer and a moose, this modification has proved to be very valuable. In both those cases we wanted every bit of braking we could find, including that from our towed vehicle.

How It Works

Original system: The exhaust brake is operated via a manual two-pole toggle switch that makes (on) and breaks (off) two circuits – (a) 12V +ve when ignition is on via red wire #1930 to exhaust brake control via white wire #1930; (b) 34 pin Cummins ECM via white wire #N15 to ground via black wire #14350.

Automatic system: The existing manual switch is retained and works as originally. A parallel two-pole relay is connected to the four wires connecting to the original manual switch. In our case, because we could not find a suitable two-pole relay, we used two simple relays purchased from Radio Shack (20 amps, an overkill), wired to (a) and (b) circuits above. Activation of the relay(s) comes from the brakes on (brake lights on) red wire #1005 which can be found in the main harness from the steering column behind the dash. To control the automatic system (turn it on/off), we connected this wire (red #1005) to one side of a small two-pole toggle switch (cheap ex Radio Shack with off/on baseplate) before running it to the relay(s) activation connection. We ran the other side of the relay(s) activation connection to the ground. We used the second pole of the small toggle switch to control a tiny red diode (also cheap ex Radio Shack), mounted high on the dash, to visually tell us that the auto brake was on, without our having to check the switch position. This light circuit we powered from the 12V +ve ignition on red wire #1930 mentioned above, passing through the small toggle switch to the light and on to ground.

Generally we leave the new auto switch on all the time, so it's always ready for an emergency stop, and leave the original manual switch off. As soon as we touch the brake pedal (a light touch that does not apply the brakes will do), the exhaust brake comes on and stays on. To release the exhaust brake, we simply touch the accelerator pedal (a light touch that does not apply engine power will do), or we can turn the switch off. Effectively, say descending a hill with tight turns, we can control the exhaust brake on/off with our right foot, without taking our hand off the steering wheel. We can still use the cruise control as it's supposed to be used. The exhaust brakes will not apply as the coach crests a hill and the brake lights continue to work as they are supposed to do. The only time we sometimes don't leave the auto switch on is when we are traveling very slowly in a city, in stop-and-go traffic. However, left on, the system is wonderful when an emergency slowdown is needed. In icy condition, one might perhaps best control the exhaust brakes with the original manual switch. ❖

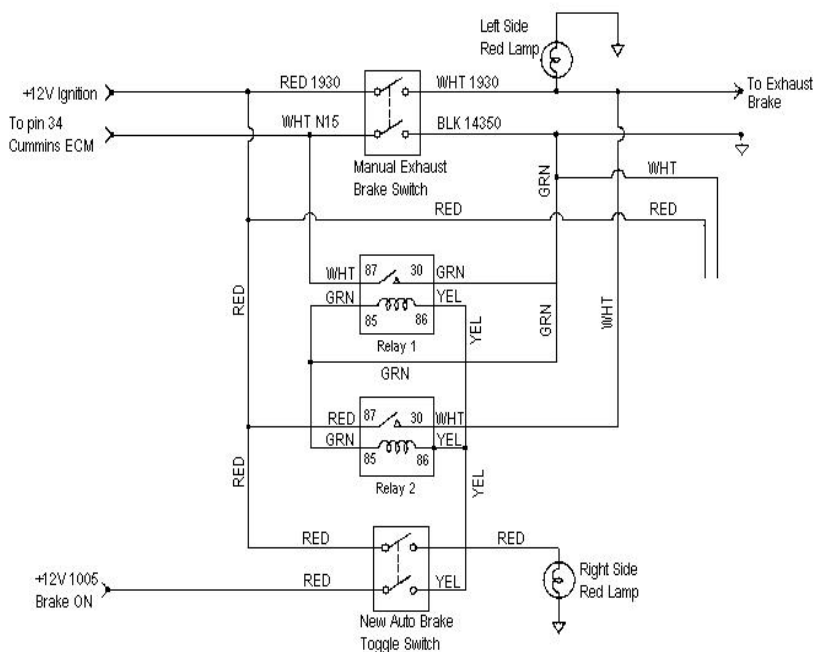

FROM THEN TO NOW, PART SIX

A brief look back at our beginnings, following the road we have traveled to the present.

A whopping 213 Discovery coaches and their owners gathered at the Wayne County, Indiana fairgrounds September 13-17, 2000. Jim and Dorothy Devine served as rally masters, with assistance from Bob Chinn, Roxie Jacobs, Marion and Harvey Becker, Marion Barton, Lois and Gene Patterson, Dick Snyder, John Schlosser, and Bill Azar who stepped up to fill a multitude of leadership positions.

It was at this rally that the first three chapters in DOAI were chartered: Discovery Pioneers, Discovery Texans, and California Goodtimers.

There were many commercial seminars by manufacturers and vendors; there was the always-favorite owners' round table with a session for the guys and another session for the gals.

Tom Raper RV of Richmond, Indiana, gave tremendous

assistance, both physically and financially, to the success of the rally. Fleetwood had a terrific and large team of factory service people, working all hours to help Discovery owners.

The members made several decisions at the general meeting: 1) Three chapters were chartered. Discovery Pioneers (Carl Ropp, President); Discovery Texans (Phil Yovino, President); and California Goodtimers (Ed Watson, President). 2) Some of the bylaws changes included establishing the position of Membership Director, Immediate Past President, Vice President of Development, and President Emeritus. 3) The title was changed from Rally Master to National Rally Master. 4) Future rallies were scheduled: Western Region winter rally at Emerald Desert Golf and RV Resort, Palm Desert, California, January 7-11, 2001; Eastern Region winter rally at Lazydays RallyPark, Seffner, Florida, February 1-4, 2001; and Western national rally at Colorado State Fairgrounds, Pueblo, Colorado, May 23-26, 2001. ❖



Bob Chinn led a spirited discussion



Rally Masters Dorothy and Jim



Yolanda DeSantis



Everyone got plenty to eat



A couple of familiar faces...
Dot and Phil Yovino



Remember these folks? Sonny and Sharon Ayer!



Everybody hula! That's a tall gal...



Leaders of the pilots' roundtable



Dose are a lotta Ds!



Discovery Pioneers received their charter. L to R, Ed and Olive Kennedy, Bob and Annie Hixson, Carl and Marge Ropp, Ted VanWinkle, Bob Chinn

RV EDUCATION 101: RV Holding Tank Tips

by Mark Polk

Today we're going to talk about RV holding tanks. To start with I wanted to mention something about RV holding tanks that I don't think a lot of RVers are aware of. Many of the free dump stations available to RVers are closing because of chemicals that are harmful to septic systems and because RVers are abusing these dump stations. If we want to have access to these dump stations it is absolutely essential that we use septic-safe chemicals (no formaldehyde), and that we clean up after ourselves and do not abuse dump stations.

Your RV has what is referred to as a gray water holding tank and a black water holding tank. The gray water holding tank collects dirty water from the kitchen sink, bathroom sink and shower. The black water holding tank is for the toilet. These tanks terminate into one main outlet used to empty the holding tanks. This is where we connect our sewer hose.

Make sure you have the required couplings and connectors. It may be necessary to attach two hoses together to reach the sewer connection. I recommend you only use heavy duty sewer hoses. They're not that expensive and they hold up much better. Keep a 10-foot hose and a 20-foot hose available. Do not pull or drag the sewer hose on the ground. This will cause it to tear or get pin holes in it.

To hook up the sewer hose, make sure both valves are closed and remove the sewer cap. Make the connection by putting the hose adapter over the outlet and turn it clockwise until it locks securely in place. Take the other end of the hose over to the campground sewer connection. Use the necessary adapters to make the connection and get a good seal. It's a good idea to place some weight over the hose so it doesn't jump back out when you drain the tanks. It may be necessary to use some type of sewer hose support to get a good angle from the RV to the campground sewer connection so the tanks drain properly when you empty them. The small valve is for the gray water tank and the large valve is for the black water tank.

One golden rule for RV holding tanks is to never dump the black water tank until it is at least two thirds full. You want the tank nearly full so the weight and the gravity will force the contents of the tank to drain properly. Another golden rule is to never leave the black tank valve open at the campground and expect the toilet to drain or flush like the toilet in your home. It won't work.

When the tanks are full, or nearly full, always dump the black tank first, followed by the gray tank. The gray water tank should also be at least two-thirds full. Dumping the gray water tank last will help to flush the sewer hose out.

When you're at the campground for an extended period of time, you can leave the gray tank valve partially open so it drains as you use it, but remember to **never** do this with the black tank. If it's time to leave the campground and your holding tanks aren't full, you can finish filling them with water and then dump them. Never use your drinking water hose for holding tank maintenance or cleaning purposes. RV drinking hoses are normally white. Take a different color hose for other uses so you can distinguish the difference.

After you dump the tanks you need to thoroughly flush the tanks out. Some RVs have a built-in system for flushing the tanks out. If not, there are other ways to do it. You can use a tank wand designed for cleaning and flushing the black tank.

The only problem is, you don't know when or if the black tank is really clean and you can't rinse or clean the gray tank with a wand.

I use a product called *Flush King*. It's a reverse flush valve that connects directly to your sewer outlet and rinses and cleans both holding tanks in one simple operation. It's easy to use and it has a see-through barrel so you know when the tanks are really clean.

Every time you dump the black tank, you need to treat it with holding tank chemicals to assist in controlling odors and to break down solids. You should always use environmentally safe chemicals. Enzyme-based chemicals use the good bacteria to digest waste and control odors. Formaldehyde-based chemicals destroy the bacteria that's needed to break down waste and they can be dangerous to humans and pets. The first step is to add enough water to completely cover the bottom of the tank. Four or five toilet bowls full should be enough depending on the size of your black tank. Water will assist a great deal with controlling holding tank odors. You always want the contents of the tank to be covered by water. Next, fill the toilet bowl and add the proper amount of holding tank chemicals, usually four ounces for every 40 gallons the tank holds. Flush the toilet. Repeat this procedure every time you empty the black water holding tank. Some holding tank chemicals like *RV Trine* also contain valve lubricants to keep the valves operating properly and extend the valve seals' life.

You should always use toilet paper designed for use in RVs. This toilet paper breaks down and dissolves in the holding tank chemicals, preventing potential problems with the holding tank, the RV sewer system and the dump station septic system.

False holding tank readings on your monitor panel are caused by the holding tank probes being covered by toilet tissue or other debris. If flushing the tank doesn't solve the problem, add some water and a couple bags of ice cubes to the empty holding tank. Drive or pull the trailer so the ice cubes can scrub the sides of the tank. Proper holding tank chemicals will also keep the holding tank probes clean.

Over time, grease and residue build up in the gray tank and this build-up causes a foul odor, not to mention how it is affecting the tank and valve assembly. Periodically treat the gray tank with environmentally safe holding tank chemicals to avoid odors from the tank. When the tank is empty, you can also add some dishwashing liquid down the drains to help break down grease and residue build-up.

Following these simple holding tank tips can prevent problems and provide you with long lasting trouble-free holding tanks. This is one problem we can all do without! All of our RV walk-through videos at www.rveducation101.com cover information on RV holding tanks, the water system, LP gas system, electrical system and more. Check out our new "RV Essential Items" DVD to show you what items you will want for your RV to make all of your RV experiences more enjoyable. Happy camping!



Mark Polk is the owner of RV Education 101. He also hosts the RV Savvy segments for RVTV, which airs on the Outdoor Channel. RV Education 101 is a North Carolina-based company that produces professional training videos, DVDs and e-books on how to use and maintain your RV so all of your RV experiences are safe, fun and stress-free.



FIGHTING SMALL FIRES

by Aon Recreation Insurance

Without question, the first rule of RV firefighting is to save lives first and property second. Your priority is to get your family safely out of the RV and then, if you can do so without endangering yourself or others, use the firefighting aids available to you.

To be most effective at fighting a fire, you must know the purposes and limitations of your equipment, as well as how to properly maintain and use it. Don't wait until a fire breaks out to try to figure out what to do. Take your extinguisher out now and have a look at it to make sure you're prepared to use it if the time ever comes. The time you save could mean the difference between minor damage and major disaster.

The Parts of a Fire Extinguisher

Most portable fire extinguishers for home use consist of six main parts you should be familiar with.

Cylinder: This is the body of the extinguisher. It is pressurized and holds some combination of extinguishing agent and expellant gas.

Handle: This is nothing more than a grip for carrying or holding the extinguisher. The type of handle design may vary according to the manufacturer. Lifting an extinguisher by the handle will not cause the unit to discharge.

Trigger: This is usually a short lever mounted above the handle at the top of the extinguisher, although some units differ. The unit will discharge when you squeeze the trigger.

Nozzle: This is at the top of the extinguisher where the extinguishing agent is expelled and often has a hose attached.

Pressure Gauge: The effective range of an extinguisher and its ability to expel all of its agent both decrease as pressure drops. Check the pressure of your extinguisher on a regular basis. Have it recharged if pressure drops below normal operating level.

Locking Mechanism: All portable fire extinguishers must come with some type of locking mechanism to prevent accidental discharge. The mechanism must be removed or released for the extinguisher to work.

Fire Extinguisher Markings

It is essential that the type of fire extinguisher you use is appropriate for the type of fire you are fighting. If, for example, you spray water on a grease fire in the kitchen, the water will cause the grease to splatter, and the fire will likely spread. If you put water on electrical equipment that is on fire, you are putting yourself in danger of electrical shock. Depending on their intended use, they use a variety of extinguishing agents (water or chemical) for putting out a fire.

Fire extinguishers are divided into classifications based on what type of materials are burning. The most common classes are A, B, and C. Following is what each class includes.

- ▶ Class A: Ordinary Combustibles - wood, cloth, rubber, paper, many plastics, fiberglass, basically anything that leaves an ash.
- ▶ Class B: Flammable Liquids - gasoline, oil, and oil-based

paint.

- ▶ Class C: Energized Electrical Equipment - wiring, fuse boxes, circuit breakers, machinery, and appliances.

Class C does not include fires involving the 12-volt equipment found in all coaches. Once you de-energize or unhook from shore power and turn off your inverter or generator, a fire that occurs is a Class A fire rather than a Class C fire.

The National Fire Protection Association requires that all motor coaches have a portable fire extinguisher that is effective on both Class B and Class C fires. The guidelines do not require that your extinguisher have a Class A rating, which would make it effective in extinguishing fires involving the materials, like wood and cloth, that make up the interior of your coach.

It's possible that your NFPA-approved fire extinguishers won't be effective to fight a fire in your RV. Check your extinguisher's markings so you'll know what materials it will work on. Ideally, you should have an extinguisher with symbols for all classes on it. But in order to get a multi-use dry chemical extinguisher effective on just a small fire, you'd have to purchase a large, heavy extinguisher, which may not be ideal for RVers.

Perhaps a better solution is to purchase a noncorrosive designer foam extinguisher. This type is effective on Class A and Class B fires, which make up over 90 percent of all RV fires. Designer foam extinguishers are user-friendly, environmentally safe, and convenient for RV travel.

While the NFPA does not require that you carry more than one fire extinguisher, don't take chances. One fire extinguisher is simply not enough. Aon's Fire & Life Safety instructor, Mac McCoy, recommends having at least two extinguishers inside of your coach - one near the door and one in the bedroom - and an additional one in an unlocked outside compartment or in your towed vehicle. Make sure that everyone traveling with you is trained to use the extinguishers.

Checking Your Fire Extinguishers

Once you've determined that you have the right type of extinguishers, the next priority is to keep them properly maintained by checking them periodically. Check the fire extinguisher gauge to determine if there is pressure in the extinguisher. If the gauge indicates empty or needs charging, replace or recharge the extinguisher immediately. To test non-gauged extinguishers, push the plunger indicator (usually green or black) down. If it does not come back up, the extinguisher has no pressure to expel its contents. If you need help testing your fire extinguishers, check with your local fire department.

Do not pull the pin and expel the contents to test your powder extinguisher. If you use a portion of the powder extinguisher, have it refilled or replaced immediately. When you have a fire extinguisher refilled, ask to shoot off the charge first (most refill stations have a special place where this can be done safely). This lets you see how far it shoots and how long a charge lasts.

Continued on the next page...

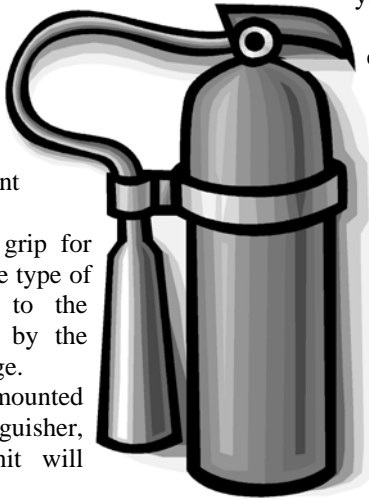

FIGHTING SMALL FIRES, CONTINUED

Invert and shake your dry powder or dry chemical extinguisher monthly to loosen the powder. The jarring of the coach while you travel down the road does not keep the powder loose; in fact, it packs the powder, which may make your extinguisher useless in fighting a fire.

How a Fire Burns

In order for fire to occur, four elements must be present:

- ▶ Fuel (wood, paper, cloth, gas, oils, fiberglass)
- ▶ Oxygen (air at between 17% and 19%)
- ▶ Heat (brakes, engine compartment, exhaust system, transmission)
- ▶ Chemical Chain Reaction (batteries, refrigerator)

If any one of these four components is missing, a fire cannot burn.

Extinguishing a Fire

There is a simple way to remember the steps to using your extinguisher to fight a fire - it's called the **P.A.S.S.** procedure. These are the four steps to follow:

- 1) **Pull the Pin:** This unlocks the operating lever and allows you to discharge the contents of the extinguisher.
- 2) **Aim Low:** Point the nozzle or hose at the base of the fire.
- 3) **Squeeze the Lever Above the Handle:** This discharges the extinguishing agent. Releasing the lever will stop the discharge.
- 4) **Sweep from Side to Side:** Moving carefully toward the fire, keep the extinguisher aimed at the base of the fire and sweep back and forth until flames appear to be out.

When using an extinguisher to put out the surface flames, make sure to totally penetrate the fuel so that it's cooled. Otherwise, the fire can flare up again. This is when having an additional fire extinguisher is important. If you use your only fire extinguisher to stop the fire and don't have another one to cool the area down, the fire could restart again and you won't have anything to fight it with.

Besides fire extinguishers, if you have a quick-disconnect fitting on your water hookup, these hoses can be unhooked instantly and be used as a tool to fight a fire. If a nearby vehicle is burning and you cannot move your coach but can safely stay close enough to keep it hosed down, you may be able to save it.

Always leave large fires to the fire department, and only fight small fires that are contained, within reach, and that you can fight with your back toward a safe escape. If you have the slightest doubt if you should fight the fire, don't attempt it! Instead get out and away fast. ❖

We thank Aon Recreation Insurance for permission to reprint this article. With nearly 40 years of experience insuring RVs, no one understands your vehicle like Aon Recreation Insurance (formerly RV Alliance America). Aon has multiple carrier options and can provide you with a policy custom-designed for the special nature of your coach. Aon also offers the added benefit of umbrella coverage, which provides liability coverage that extends beyond your RV, home, and auto insurance policies to protect you from a costly lawsuit. To get a quote, call Aon at 800.521.2942, or visit www.aonrecreation.com for more information.



TIPS AND TRICKS FOR TRAVELING MICROWAVES

Microwave ovens offer convenient cooking options whether at home or on the road. With the latest in microwave innovations, you can create masterful meals with just the touch of a few buttons. But can the same microwave be used in your home and RV kitchens?

"RVers have an important decision to make when it comes to RV microwaves," says Dr. Dometic. "While some microwaves are designed for travel, others are not. It is important to be well informed before placing just any appliance in your RV."

RV microwaves, such as those made by Dometic, are designed and installed for safety on the road. These microwaves feature special venting to make sure the appliance operates correctly and safely. Built-in and over-the-range models must be properly vented so that neighboring cabinets do not become overheated, causing a potential fire hazard.

Another risk associated with using a countertop microwave purchased from a discount store is that it can cause damage in transit if it is not properly secured in place. RV manufacturers provide trim kits to properly secure a microwave. This prevents movement and possible damage during travel. A free-standing model should be properly stored

while traveling so that it won't move.

Dr. Dometic advises to check the warranty on residential microwaves. "Some models say 'not for use in RVs,' so be sure to read the fine print before placing one in your RV." Models sold in discount stores are not built with the intent that the product will be used in an RV, so be sure to read manufacturer's notes on proper usage.

During travel, be sure not to place or store items in the microwave, as movement and sudden braking could put pressure on the door, causing it to break.

"Microwaves designed especially for RVs have some great features and functionalities," Dr. Dometic says.

RV microwave ovens now deliver the multiple cooking functions and programming conveniences you expect in the most advanced residential models. Microwave-convection ovens even crisp and brown meat for an appetizing look and taste. A multi-stage cooking feature on select models is especially handy for cuisine that requires slow heating.

Now it is possible to make moist banana bread and mouth-watering Cornish hens even while RVing. Innovations in microwave ovens have made delicious delights just a few key strokes away. But to make that possible, be sure to purchase a microwave that is specially built for traveling. ❖

An RV enthusiast and expert, Dr. Dometic has written a series of articles on important RV issues. This is the second in a series, and was reprinted with permission of Dometic and Bj Thompson Associates.



Southeast 2007 Region Rally – Sun-N-Fun Rally
Lazydays RallyPark, Seffner, Florida – Phone 800.905.6627
ARRIVAL: Tuesday, February 13 – DEPARTURE: Saturday, February 17
Early Arrival: Monday, February 12 – Late Departure: Sunday, February 18

Please complete this two-part registration form. Send Part I to Lazydays RallyPark, and send Part II to Marshall Godwin, Registrar

▶ ▶ ▶ MAKE A COPY FOR YOUR RECORDS ◀ ◀ ◀

PART I: CUT ON LINE BELOW AND MAIL TO LAZYDAYS RALLYPARK

Discovery Owners Association Sun-N-Fun Rally – February 13-17, 2007

Last Name _____ First Name _____ Phone _____

Street, City, State, ZIP _____

Discovery Year _____ Model _____ Length _____

Arrival Date _____ Departure Date _____ Handicap Parking? Yes No

Site Fee: \$168.00 (5 days/4nights) Additional Night/s: \$39.19/night

Make check payable to LAZYDAYS RALLYPARK and mail to:
Lazydays RallyPark, 6210 CR 579, Seffner FL 33584-2968

Check Amount _____

For credit card payment: Card # _____ Expiration Date _____

If paying by credit card, you can mail or fax this form to Lazydays (813.246.5504)

Cancellation Policy: Prior to 30 days, no charge; between 30 and 7 days, one day's charge; less than 7 days, no refund.

PART II: CUT ON LINE BELOW AND MAIL TO MARSHALL GODWIN, REGISTRAR

Pilot's Last Name _____ First Name _____ Co-Pilot _____

Phone _____ Cell _____ E-mail _____

Street, City, State, Zip _____

DOAI # _____ Arrival Date _____ Departure Date _____

Handicap Parking? Yes No Is this your first DOAI rally? Yes No Are you a full-timer? Yes No

Emergency Contact Name _____ Telephone _____

Rally Fee: \$40.00 per coach for two people, or \$20.00 for one person
\$20.00 for each additional guest.

Check Amount _____

Guest/s Name and Address _____

Make check payable to DISCOVERY OWNERS ASSOCIATION, INC. and mail to:
Marshall Godwin, 103 Riverview Cir, Colonial Beach VA 22443-4816
Phone (H) 804.224.4206; (C) 540.379.6767; godwin.marshall@kingfishersys.com

NO REFUND AFTER JANUARY 15, 2007

ITEMS FOR SALE

This section is available to any DOAI member, free of charge, on a space-available basis. Send information to the editor, preferably via e-mail. Include full information. Sale/wanted items will run in a limited number of issues. Visit the DOAI Web site (www.discoveryowners.com) for color photos of Discoverys for sale and for much more information than we can include here.

DISCOVERY MOTOR HOMES FOR SALE

1998 - 36T: Well maintained, 61,000 miles, no smoke/no pets. New tires at 45,000 miles, mounted spare tire, external tire rack. Coupled propane tanks, built-in closet with clothes hamper, Purge water tank system. Located in Florida. Bernie Abbott; 561.615.4509; cell 561.236.5811; blabbott11@aol.com **Price: \$50,000 OBO**

1999 - 36T: Cummins ISB 275, Allison 6-speed tranny, Cummins RoadRelay system, Onan 6.5KW gen, 1KW inverter, power mgmt system, cooktop and oven, LP extended stay connection, full awnings all around, XRV tires w/two spares and covers. 49,000 miles. Price includes two free City Bug electric scooters. See <http://99Discovery.home.comcast.net>. **Gene Hamelman;** 972.495.6342; g-mann@comcast.net. **Price: \$72,000 NEGOTIABLE**

1999 - 36T: 300 HP Cummins, very good condition, no smoke/no pets, 59,000 miles, 11 mpg, kitchen, living room slide, leather loveseat/couch, dining booth, MW/convec, refrig/freezer w/icemaker, new carpeting, two ACs, two TVs, satellite and regular antenna, leather seats, LP gen, new batteries; front tires have 15,000 miles; tow package including optional 1991 Tracer wagon. Everything works. **Rob Hess;** 918.756.1316; fax 918.756.1315; rhess@firsttokmulgee.com. **Price: \$71,900 with tow car; \$69,900 without tow car**

1999 - 36T: Cummins ISB 275 HP, 6-speed Allison tranny, large slide-out. Front bra, Blue Ox tow bar, Safe-T-Steering control, AC protection screens added. New SRV tires at 44,200 miles; current mileage 46,518. Maintenance performed routinely. Exterior snap-on windshield and front windows sun coverings. Extra drawer added under sofa and loveseat. Original owners, no smoke/no pets. Located in Colorado. Gordon Grimes; 303.797.1481; cell 720.810.1343; g.grimes@att.net **Price: \$68,950**

1999 - 37V: 30K miles, original owner, always garaged, no smoking/no pets. Two slides, Cummins 275 diesel eng, dining table w/4 chairs, computer desk, CB radio, awnings all around, spotlight, front bra, Howard supplemental steering system, engine heater. Located in Colorado. Frank Howell; 719-547-3508; cell 719-648-3856; fdhowell@att.net **Price: \$79,500**

2000 - 37V: Cummins 300 ISB, 49,000 miles, purchased new in 2000 by current owner, excellent condition, no smoking/no pets, two slides, King Dome, CB radio, new front tires, new coach and engine batteries, propane cooktop and oven, dinette table/four chairs, awnings all around, two leather La-Z-Boy™ recliners. All maintenance current, all records/manuals available. Located in Arizona. Bob Larkin; 480.802.3826; larkinb@wbhsi.com **Price: \$86,000 NEW PRICE**

2001 - 37G: Loaded, non-smokers, washer/dryer, central vac system, diesel gen, all leather interior, alder cabinets, etc. 52,000 miles, well taken care of. Located in Florida. Ron Zimmerman; 407.330.1658; gnopgnip1@bellsouth.net **Price: \$75,900 NEW LOWER PRICE**

2002 - 38D: 330 Cat, in-motion satellite for TiVo, CB, extra large/extra quiet water pump w/custom water area, electric awning, awnings all around, windshield see-through sun cover, tire covers, two large solar panels w/solar boost and Trace meter good for two weeks' dry camping with one person showering every day and TV 24/7. Venturi quiet roof vent w/six new batteries, walnut cabinets, custom walnut desk and shelves, custom faucets throughout, cooktop and oven, custom bedroom and closet shelves, electric blind on driver side and windshield. Barry Jacobs; 951.805.6992; kathynjake@hotmail.com **Price \$120,000 (or \$125,000 with TT/RoD/RPI campground memberships)**

2002 - 38P: Cat 330, two slides, Allison 6-speed tranny, Onan 7.5KW gen, washer/dryer, two ACs, all leather interior, 2KW inverter, low miles, mint condition. Located in Ohio. Raymond Martin; 513.777.7507 until Oct. 15, then 813.642.9248; dwe1835@wmconnect.com **Price: \$118,900 PRICE LOWERED**

2003 - 39S: Three slides, equipped with every top-of-the-line option, awnings for every window. 330 HP Cat engine, two swivel/recliners, dining table and chairs, custom cherry built-ins, more. 13,800 miles, bought new. No smoking/no pets. Plus 1997 Jeep Cherokee, all leather, all options, 72,000 miles, bought new, garaged, perfect care, hitch, hook-ups, etc. Located in Alabama. **Will sell without Jeep.** Burell Boyd; 256.796.2668. **Price for RV only: \$119,000; price for both: \$125,000**

2003 - 39S: Cat 330HP, 3 slides, cherry interior finish, 12,000 miles, no smoke/no pets, mint condition, transferable warranty, many extras. Don Vanderheiden; 308.785.2285; cell 308.870.1257; donjan26@msn.com **Price: \$119,000 NEGOTIABLE**

2006 - 39C: Three slides, enclosed bathroom, hallway, 13,000 miles, original owner. James Rifenberg; 561.329.4729; jimmyrife@aol.com **Price: \$150,000 OBO**

RV-RELATED ITEMS FOR SALE

DON'S HUB NUT WRENCH: Can be used on most coaches on a Freightliner chassis with aluminum wheels and the screw-in decorative nut. Donald Cullins, 9025 Robinhood Cir., Westerville, OH 43082-9665; scdc432@sbcglobal.net. **Price: \$12.95 each plus \$3 s/h**

OVER-DOOR AWNING by Oasis, like new, \$300; **SMALL ELECTRIC SCOOTER** \$100; and **WINDSHIELD CHIP REPAIR KIT**, price negotiable. Will have these at the San Antonio rally in October. Joyce Bednarczyk; bedchk@peoplepc.com.

ADCO RV COVER: Never taken out of the box. Fits full-size RV 33.7 ft to 37 ft. Marge Jordan; 229.931.9009; jjmarge@yahoo.com **Price: \$250**

ROADMASTER BASE PLATE including installation instructions for 2004 Jeep Grand Cherokee. Will not fit any other model. **Price: \$350 plus shipping.** **TOW CAR COVER**, vinyl with flannel back. Fits Jeep Grand Cherokee, but may fit other cars. **Price: \$100 plus shipping.** Gar Collick; 989.864.5429; garnjudy@isp.com

10th National DOAI Rally!
Discoverys in the Desert
NOVEMBER 6-10, 2007
TOURS AND GOLF – NOVEMBER 4 AND 5, 2007



REGISTRATION FORM

Please PRINT legibly or TYPE all information

Pilot's Last Name _____ First Name _____
 Co-Pilot's Last Name _____ First Name _____
 Street _____ City, State, ZIP+4 Code _____
 Home Phone _____ Cell Phone _____
 Need handicap parking? Yes _____ No _____ E-Mail _____
 DOAI # _____ DOAI Region Affiliation _____ First National Rally? _____
 Are you? DOAI Officer _____ Chapter Officer _____ Chapter _____
 Guest(s) Name, City, State _____

Registration:

\$220.00 per coach with two adults (November 6-10) \$ _____
 \$180.00 per coach with one adult (November 6-10) \$ _____
 \$60.00 each additional person (November 6-10) x _____ persons = \$ _____

Early Arrival and Events:

Sun. Nov. 4 _____ Mon. Nov. 5 _____ x \$30.00/night = \$ _____
Tour 1: Mon., Nov 5 - Heard Museum (limit 50) \$20.00 x _____ persons = \$ _____
Tour 2: Tues. Nov. 6 - Luke AFB w/lunch (limit 50) \$25.00 x _____ persons = \$ _____
Golf: \$50.00 x _____ persons = \$ _____
 \$20 DOAI membership (if not already a DOAI member) \$ _____
 → → **MAKE CHECK PAYABLE TO: DISCOVERY OWNERS ASSN., INC.** Check Enclosed \$ _____

Mail check and registration form to: Geri Cozens, Registrar, PO Box 17402, Munds Park, AZ 86017-7402
QUESTIONS? Call Geri (602.274.9422) or send e-mail (*edcozens@yahoo.com*)
REGISTRATION MUST BE RECEIVED BY OCTOBER 15, 2007
LATE REGISTRATION - \$25 LATE FEE, AND SUBJECT TO SPACE AVAILABILITY
LIMIT OF 150 COACHES
 → → **COPY FORM FOR YOUR RECORDS – NO SHOW, NO REFUND** ← ←
YOU WILL RECEIVE A CONFIRMATION OF YOUR REGISTRATION VIA E-MAIL.

Please indicate your interest: Red Hat Social Parade of Homes

WE NEED VOLUNTEERS! Please volunteer for any of the following tasks:

- | | | | |
|--|--|--------------------------------------|--|
| <input type="checkbox"/> Registration | <input type="checkbox"/> Door Prizes | <input type="checkbox"/> Golf Helper | <input type="checkbox"/> Workshop Helper |
| <input type="checkbox"/> Reporter | <input type="checkbox"/> Seminar Helper | <input type="checkbox"/> 50/50 Game | <input type="checkbox"/> Vendor Helper |
| <input type="checkbox"/> Photographer | <input type="checkbox"/> Clean-up Helper | <input type="checkbox"/> First Aid | <input type="checkbox"/> Where Needed |
| <input type="checkbox"/> Unique Talent _____ | | | |

EDITOR'S RAMBLINGS

by Nina Lee Soltwedel

Two issues ago I was all excited about it being spring once again. Then the hot weather settled in for a 'way-too-long-a-stay, and that delight in the season change scampered away. Here in the Rocky Mountain west we suffered from too much sun and too little moisture...a situation which seems to be worsening. I'm beginning to think those who claim global warming is real may just be right.



And so it is with some relief that I welcome fall. But, then, fall has always been my favorite season. I was born and raised in Wisconsin, and golly! the fall seasons there are gorgeous, with the thousands of maple trees aflame and so bright that even gloomy days have a glow of sunshine about them. I loved the smell of leaves burning, the rustling sounds as I walked along sidewalks covered with fallen leaves, the incredibly blue skies of October sunny days, and the heady aroma of freshly picked Macintosh apples. I hope wherever you are that you, too, are enjoying this fall season.

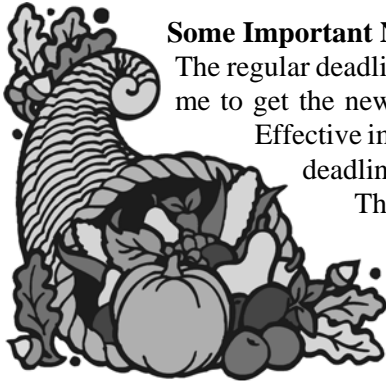

Some Important News

The regular deadline for submitting news items for *Discovery EXPRESS* has been adjusted to enable me to get the newsletter to you closer to the beginning of the quarter, rather than in the middle.

Effective immediately, the **deadline** for the Winter issue is **November 20**. Succeeding issues' deadlines are: Spring - **February 20**; Summer - **May 20**; and Fall - **August 20**.

This change will also allow me to enjoy the Christmas holidays more, knowing I don't have to be at the computer for several days during the height of the season. I thank you in advance for your cooperation.

Have a wonderful fall and drive safely. Happy Halloween, Happy Thanksgiving, Happy Christmas, and don't forget to vote! ❖

DISCOVERY OWNERS ASSOCIATION, INC. MEMBERSHIP APPLICATION

Welcome to an organization open to all owners of Discovery motor homes by Fleetwood RV. DOAI is an organization intended to foster social opportunities and information exchange among members.

PLEASE...PAYABLE IN U.S. FUNDS ONLY!
Questions? Call 888.594.6818

Dues are \$20.00 for the first year*; \$16.00 for one year renewal; \$45.00 for three years, or \$75.00 for five years. *New members pay an additional \$4.00 one-time administrative fee.

Mail the form below with your check payable to *Discovery Owners Association, Inc.* to:
PORTIA WILLIAMS, MEMBERSHIP DIRECTOR
P. O. BOX 95
ST. GEORGE, UT 84771-0095

Pilot Last Name _____ First _____ Co-Pilot _____

Address _____

City, State, ZIP+4 Code _____

Home Telephone _____ Cell Telephone _____

Discovery Year _____ Length and Model _____ E-Mail Address _____

Is this your first RV? Yes _____ No _____ Are you a full-time or part-time RV'er? _____

Who recommended DOAI membership to you? _____

Check enclosed for \$ _____ representing (check one): One year Three years Five years

Discovery Owners Association, Inc., thanks these fine manufacturers for sponsoring this newsletter



Discovery Owners Association, Inc.

Portia Williams, Membership Director
P. O. Box 95
St. George, UT 84771-0095

ADDRESS SERVICE REQUESTED

**ARE YOUR DUES DUE?
Please renew now!**

